

Plastic Consumables Catalogue 2024

www.sichim.com

INDEX

Pipette Tips	3
Filtered Pipette Tips Rack.....	3
Non-Filtered Tips Bags	4
Tips Compatible with RAININ LTS Pipette.....	4
Compatible Chart of Filter Tips and Pipettes.....	5
Pipettes	6
Serological Pipette	7
qPCR Consumables	8
8-Tube Strip	8
96-well qPCR Plate.....	9
96-well qPCR Plate.....	10
qPCR 96wells-Plate Compatibility Chart	11
Sealing Films	12
Centrifuge Tube	13
Microcentrifuge Tubes.....	13
Conical-Bottom Centrifuge Tube.....	14
Centrifuge Tube Racks	15
Cryovial Tubes.....	16
Storage Boxes	17
Storage Plastic Boxes	17
Storage Carton Boxes.....	18
Cell Culture Plate	19
Cell Culture Flask	20
Cell Culture Dish	21
Cytology Brush	22
Gloves	23

About Us

Fisher Molecular Biology is an innovative Biotech Company, specialized in the production of reagents for Molecular Biology and Life Sciences, has acquired diversified know-how in the past years and has a long and productive cooperation with advanced Research Center both with Italian and international Universities. These types of collaboration were created with one major goal: to produce reliable, high quality products to be utilized in the sector of biotechnologies.

In the early years, our company concentrated on the production of PCR products, dNTPs, DNA Markers and this is, to date, our with a strong focus on Life Science.

We hope that you continue to support this field of research. Our pledge is to assure high quality products, competitive pricing and technical support.

[Innovative Biotech Company](#)

Pipette Tips

Pipette tip is a commonly used lab consumable in experiments of life science research, biosafety research, agricultural breeding, Biomedical industry, Etc. The quality of the tips can determine the accuracy and precision of pipetting. Fisher technology is committed to providing professional products and services for life science researchers and launched a variety of high-quality pipetting tips to ensure the accuracy of every pipetting operation. All pipette tips are manufactured in a ISO9001-Certified workshops with high-standards. It has a class 100,000 cleanroom for producing, a class 10,000 assembly workshops, and a high-precision mold R&D and production workshops.



Filtered Pipette Tips Rack

► Product Features

Filtered tip, equipped with a highly hydrophobic filter element inside, can effectively isolate the aerosol contamination and avoid the contact between the sample reagent and the front end of the pipette, thereby prevent the cross-contamination between the pipette and the sample. The excellent characteristics of filtered tip makes it widely used in various high-demand pipetting operations, such as SARS-CoV-2 detection experiment. All the Low retention Pipette are DNase/RNase-free.

Cat.No.	Volume	Description	Packing
FT-10-LR	10 μ l	Sterile Filtered Low retention Pipette Tip, 10 μ L	10 Rack/96 Well
FTL-10-LR	10 μ l	Sterile Long Filtered Low retention Pipette Tip, 10 μ L	10 Rack/96 Well
FT-20-LR	20 μ l	Sterile Filtered Low retention Pipette Tip, 20 μ L	10 Rack/96 Well
FT-100-LR	100 μ l	Sterile Filtered Low retention Pipette Tip, 100 μ L	10 Rack/96 Well
FT-200-LR	200 μ l	Sterile Filtered Low retention Pipette Tip, 200 μ L	10 Rack/96 Well
FT-1000-LR	1000 μ l	Sterile Filtered Low retention Pipette Tip, 1000 μ L	10 Rack/96 Well

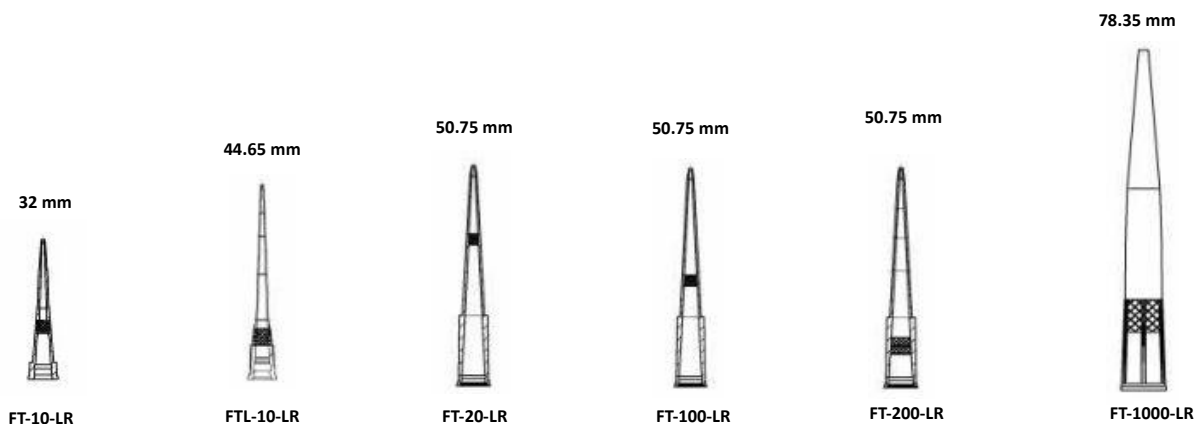

Non-Filtered Tips Bags

- Made in medical-grade polypropylene, has smooth inner wall and less liquid residue;
- Crystal clear body, easy to observe and calibrate the liquid absorption;
- Thin-wall design, with good flexibility and sealability;
- Innovative design, has good pipette adaptability (suitable for aver 95% of brand pipettes);
- Can be autoclavable;

Cat.No.	Volume	Description	Packing
NFT-10	10 µl	Universal Pipette Tip, 10 µl	1000 Tips/Bag
NFTL-10	10 µl	Long Universal Pipette Tip, 10 µl	1000 Tips/Bag
NFT-20	20 µl	Universal Pipette Tip, 20 µl	1000 Tips/Bag
NFT-200	200 µl	Universal Pipette Tip, 200 µl	1000 Tips/Bag
NFT-1000	1000 µl	Universal Pipette Tip, 1000 µl	1000 Tips/Bag

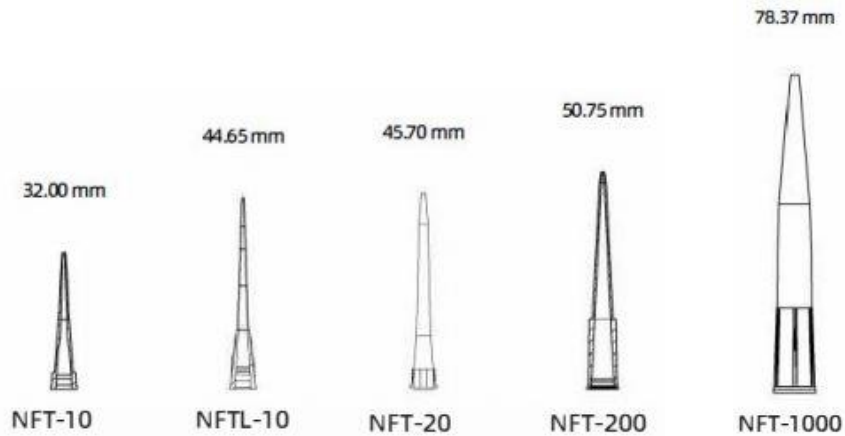

Tips Compatible with RAININ LTS Pipette

Cat.No.	Volume	Description	Packing
LTS-20-FT	20 µl	Sterile Rainin LTS-compatible Filtered Pipette Tip, 20µL	10 Rack/96 Well
LTS-200-FT	200 µl	Sterile Rainin LTS-compatible Filtered Pipette Tip, 200µL	10 Rack/96 Well
LTS-1000-FT	1000 µl	Sterile Rainin LTS-compatible Filtered Pipette Tip, 1000µL	10 Rack/96 Well

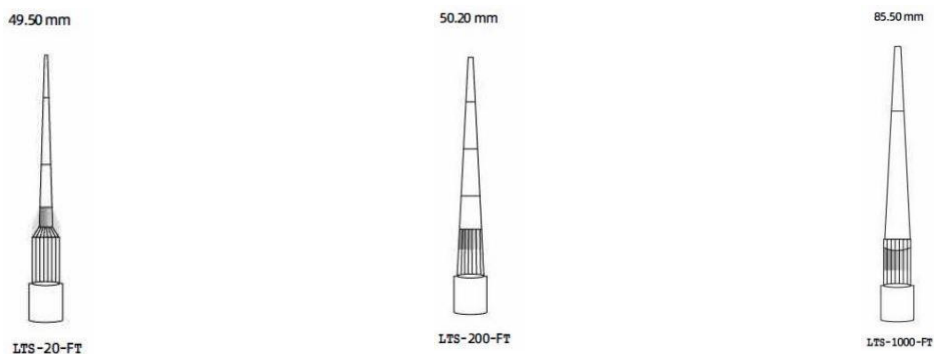

Compatible Chart of Filter Tips and Pipettes

Pipette Brand	Pipette Channel	Pipette Model	Pipette Specification	Specification of Fisher Molecular Biology Pipette Tips					
				10µL (filtered)	10µL Ext. (filtered)	20µL (filtered)	100µL (filtered)	200µL (filtered)	1000µL (filtered)
Eppendorf Research Plus	Single Channel	3120000216	0.1-2.5µL		✓				
		3120000224	0.5-10µL	✓	✓				
		3120000232	2-20µL			✓			
		3120000240	10-100µL				✓		
		3120000259	20-200µL					✓	
		3120000267	100-1000µL						✓
	Multi-Channel	3122000019	0.5-10µL	✓					
		3122000035	10-100µL				✓		
3122000051		30-300µL					✓		
Gilson Pipetman Classic	Single Channel	P2	0.2-2µL	✓	✓				
		P10	1-10µL	✓	✓				
		P20	2-20µL			✓			
		P100	10-100µL				✓		
		P200	20-200µL					✓	
		P1000	100-1000µL						✓
	Multi-Channel	P10	1-10µL	✓					
		P20	2-20µL			✓			
		P200	20-200µL				✓	✓	
	/	100-1200µL							
Rainin*	Single Channel	SL-10 PL+	0.5-10µL	✓	✓				
		SL-20 PL+	2-20µL			✓			
		SL-100 PL+	10-100µL				✓		
		SL-200 PL+	20-200µL					✓	
		SL-1000 PL+	100-1000µL						✓
Brand Sigma	Single Channel	705869 D-2.5	0.1-2.5µL	✓	✓				
		705870 D-10	0.5-10µL	✓					
		705872 D-20	2-20µL			✓			
		705873 D-50	5-50µL			✓			
		705874 D-100	10-100µL			✓			
		705878 D-200	20-200µL					✓	
		705880 D-1000	100-1000µL						✓
	Multi-Channel	705900 M8-10	0.5-10µL	✓					
		705908 M8-100	10-100µL				✓		
		705912 M8-300	30-300µL					✓	
Thermo Finnpipette Variable Volume	Manual Single Channel F3	4640000	1-10µL	✓	✓				
		4640020	2-20µL	✓	✓				
		4640040	10-100µL			✓	✓		
		4640050	20-200µL					✓	
		4640060	100-1000µL						✓
	Multi-Channel F2	4662000 (1-10)	0.5-10µL	✓					
		4662020	10-100µL				✓		
		4662030 (30-300)	50-300µL					✓	

*(not compatible with Rainin Pipet-Life LTS Pipette "Life Touch")



Pipettes

Pipette, also known as a pipette gun, is a device used for quantitative liquid handling. A pipette is generally used for small or micro pipetting of liquid when conducting studies for analytical testing.

- Single channel: 0.1-2.5 μ L, 1-10 μ L, 2-20 μ L, 10-100 μ L, 20-200 μ L, 100-1000 μ L, 1000-5000 μ L, 1-10 mL
- Multi-channel: 1-10 μ L, 5-50 μ L, 50-300 μ L, 100-1000 μ L



Cat.No.	Channel	Volume	Volume Range	Increment	Color
FS-PIP2.5	Single	2.5 μ L	0.1-2.5 μ L	0.05 μ L	White
FS-PIP10	Single	10 μ L	1-10 μ L	0.1 μ L	Yellow
FS-PIP20	Single	20 μ L	2-20 μ L	0.2 μ L	Orange
FS-PIP200	Single	200 μ L	20-200 μ L	1 μ L	Red
FS-PIP1000	Single	1000 μ L	100-1000 μ L	5 μ L	Grey
FS-PIP10CH	8-Channel	10 μ L	1-10 μ L	0.1 μ L	Grey
FS-PIP50CH	8-Channel	50 μ L	5-50 μ L	0.5 μ L	Grey
FS-PIP300CH	8-Channel	300 μ L	50-300 μ L	1 μ L	Grey
FS-PIP1000CH	8-Channel	1000 μ L	100-1000 μ L	5 μ L	Grey

Serological Pipette

Serological Pipette, is mainly used for large volume pipetting operations in biological experiments such as cell culture and tissue culture, and can be used with electronic pipettes and other automation platforms. A variety of volumes are available, and different volume specifications correspond to different color for easy identification. Special filtered design can protect your samples and instruments from contamination.



► Product Features

- Made of medical-grade polystyrene (PS), has high transparency;
- Available in various volume including 1 ml, 2 ml, 5 ml, 10 ml, 25 ml, 50 ml;
- Bidirectional graduation design, easy-to-read fluid volumes and dispensing amounts;
- Precise pipetting with dispensing accuracy within $\pm 2\%$;
- High quality filters, effectively isolate aerosol contamination;
- Smooth and transparent inner surface, has good hydrophobicity;
- Different colors correspond to different volumes, easy to distinguish;
- Sophisticated manufacturing techniques and mold design, to guarantee product quality consistency;
- Individually wrapped with either papers/plastic, easy to use;
- E-Beam irradiation sterilized, DNase/RNase/Pyrogen free

Cat.No.	Volume	Color	Graduation	Description	Packing
SP-1005	1 ml	Yellow	1/100ml	Serological Pipettes, Yellow Ring Mark, Pre-Sterilized, Individuai Package, 1 ml	200 Pcs/Box
SP-2005	2 ml	Green	1/100ml	Serological Pipettes, Green Ring Mark, Pre-Sterilized, Individuai Package, 2 ml	200 Pcs/Box
SP-3005	5 ml	Blue	1/100ml	Serological Pipettes, Blue Ring Mark, Pre-Sterilized, Individuai Package, 5 ml	200 Pcs/Box
SP-4005	10 ml	Orange	1/100ml	Serological Pipettes, Orange Ring Mark, Pre-Sterilized, Individuai Package, 10ml	200 Pcs/Box
SP-5005	25 ml	Red	1/100ml	Serological Pipettes, Red Ring Mark, Pre-Sterilized, Individuai Package, 25 ml	100 Pcs/Box
SP-6005	50 ml	Purple	1/100ml	Serological Pipettes, Purple Ring Mark, Pre-Sterilized, Individuai Package, 50 ml	100 Pcs/Box



qPCR Consumables

qPCR (Real-time quantitative PCR) experiments are commonly used in modern biological research, such as basic life science research, food safety testing, medical research, and even clinical disease detection. The accuracy and convenience of the operation have received increasing attention from researchers. The accurate experimental results depend on not only the high precision of the instrument itself, but also high-quality reagents and high-quality compatible consumables. Fisher technology is committed to providing professional products and services for life science researchers and launched the AI series of high-quality qPCR experiments related consumables.

Tube Strip

The Fisher a-strip PCR Tubes are manufactured in a ISO13485-Certified workshops with ultra-high standards. It has a class 100,000 cleanroom for producing, a class 10,000 assembly workshops, and a high-precision mold R&D and production workshops. We control all links from raw material procurement to product sales, and implement standardized management to ensure product quality is reliable and uniform. We hope to provide higher-end products through strict standards to meet your every experimental needs.

► Product Features

- Made of pure medical-grade polypropylene. Excellent performance in optics, tolerance, flexibility, air tightness, thermal deformation stability, etc.
- Produced in a class 100,000 cleanroom to ensure the product DNase/RNase/Pyrogen free.
- Innovative tube body design and injection molding process, high mechanical stability.
- Minimized sample and reagent adsorption, to guarantee the accuracy and precision of the reaction system.
- Reliable sealing effect, Ultra-thin tube wall, optimal sample heat transfer, suitable for real-time fluorescence qPCR experiments;
- The compatible cap has good light transmittance to guarantee the accuracy of the experiments

Cat.No.	Color	Volume	Description	Packing
FS-1820-8STRIP	Clear	0.1 ml	8-Tube Strip with Flat Caps, 0.1 ml	125 Strips/Box
FS-4820-8STRIP	Clear	0.2 ml	8-Tube Strip with Flat Caps, 0.2 ml	125 Strips/Box



96-well qPCR Plate

Fisher qPCR Plate are manufactured in a ultra high-standard production workshop. With the precise mold design, every qPCR plate can be better compatible with your real-time fluorescence qPCR instrument. Using with the FMB series of pressure-sensitive Plate Sealing Film or adhesive Sealing Film can guarantee excellent sealing performance and extremely low evaporation rate during the experiment. For some ABI fluorescence qPCR instruments, Fisher has also added the 0.1 mL fast reaction module adapter plates and 0.2mL standard reaction module adapter plates and 0.2 mL standard reaction module adapter plates to our PCR plate series.

► Product Features

- Made of high purity medical-grade polypropylene;
- Perfect with mainstream fluorescent qPCR instruments on the market;
- Made in Class 100,000 cleanroom, DNase/RNase/Pyrogen free.
- Using superior quality materials and advanced manufacturing techniques, to ensure the minimal light loss, suitable for real-time PCR;
- Ultra-thin and uniform tube wall, guarantee the excellent light transmission and thermal conductivity;
- Ultra-low adsorption, guarantee the accuracy of the experimental system.

Cat.No.	Cut	Skirt	Color	Volume	Packing
FSP -NS1002-96	A 12 & H12	No-Skirted	Clear	0.1 mL	50 Plate
FSP -NS1002W-96	A 12 & H12	No-Skirted	White	0.1 mL	50 Plate
FSP -HS3002W-96	H12	Half-Skirted	White	0.1 mL	50 Plate
FSP - HS 3002-96	H12	Half-Skirted	Clear	0.1 mL	50 Plate
FSP - HS 6002-96	A12	Half-Skirted	Frosted	0.2 mL	50 Plate
FSP - HS 7002-96	A1	Half-Skirted	Frosted	0.1 mL	50 Plate
FSP - HS 8002-96	H1	Half-Skirted	Clear	0.2 mL	50 Plate
FSP -NS9002-96	H1	No-Skirted	Clear	0.2 mL	50 Plate
FSP -FS1002-96	H1	Full-Skirted	Clear	0.1 mL	50 Plate
FSP -FS1002W-96	H1	Full-Skirted	White	0.1 mL	50 Plate
FSP -NS9601-96	A 1 & H1 & H12	No-Skirted	Clear	0.1 mL	50 Plate
FSP- HS9601-96	A 1 & H1	Half-Skirted	Clear	0.1 mL	50 Plate
FSP- HS9602-96	A 1 & H1	Half-Skirted	Clear	0.2 mL	50 Plate



96-well qPCR Plate

Product description	FSP-NS1002-96	FSP - NS1002W-96	FSP - HS3002W-96	FSP - HS3002-96	FSP - HS6002-96	FSP - HS7002-96	FSP - HS8002-96	FSP - NS9002-96	FSP - FS1002-96	FSP - FS1002W-96	FSP - NS9601-96
		Clear	White	White	Clear	Frosted	Frosted	Clear	Clear	Clear	White
Recommended reaction volume	5-125µl	5-125µl	5-125µl	5-125µl	5-125µl	5-125µl	5-125µl	5-125µl	5-125µl	5-125µl	5-125µl
Max volume	200 µl	200 µl	200 µl	200 µl	300 µl	200 µl	300 µl	300 µl	200 µl	200 µl	200 µl

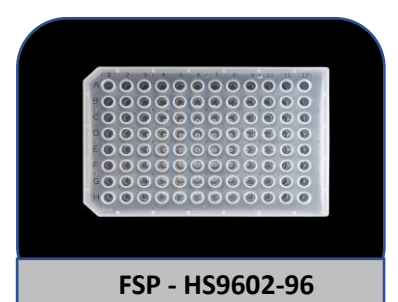
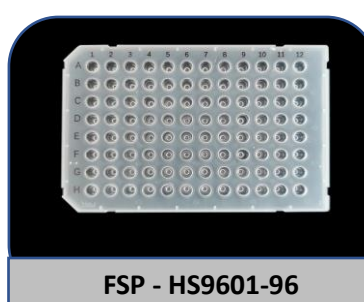
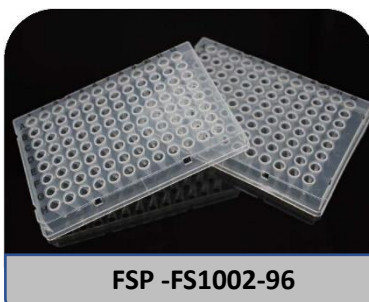
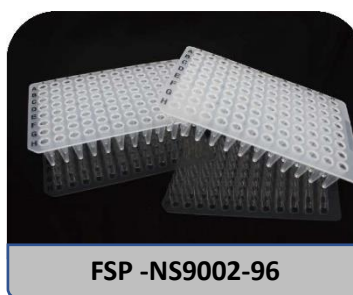
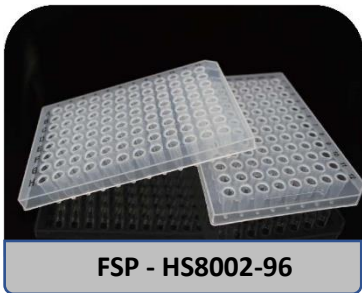
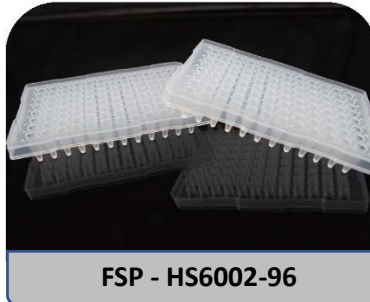
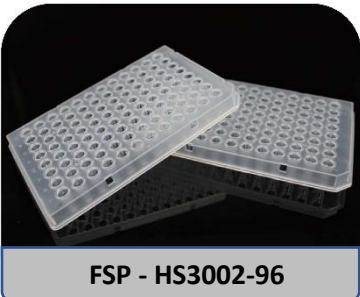
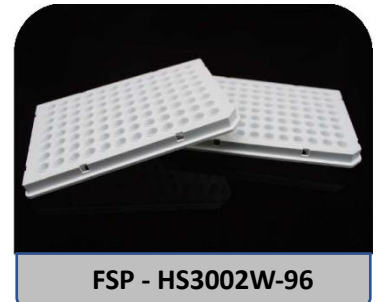
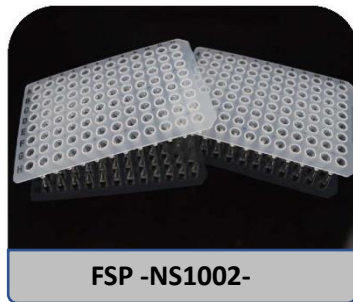
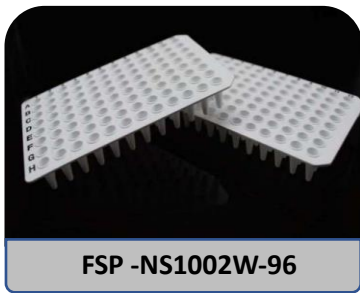

qPCR 96wells-Plate Compatibility Chart

CUT CORNER		A12&H12	A12&H12	H12	H12	A12	A1	A12	H1	H1	H1	H1,A1&A12	
BRAND	MODEL	FSP-LP1002W	FSP-LP1002	FSP-SK3002W	FSP-SK3002	FSP-SK6002	FSP-SK7002	FSP-SK8002	FSP-LP9002	FSP-FS1002	FSP-FS1002W	FSP-NS9601	
		White	Clear	White	Clear	Frosted	Frosted	Clear	Clear	Clear	White	Clear	
Thermal cycler	ABI	2700							*	*		°	
		2720							*	*		°	
		9700	°	*	°	*			*	*		°	
		Verti (0.1 ml)											°
		Verti (0.2ml)							*	*			°
		Verti Pro							*	*			°
		ProFlex							*	*			°
		SimpliAmp							*	*			°
		MiniAmp							*	*			°
		MiniAmp Plus							*	*			°
	Bio-Rad	iCycler							*	*			°
		T100							*	*			°
		51000							*	*			°
		Cl 000/Cl 000 Touch							*	*			°
	Eppendorf	Mastercycler Pro							*	*			°
		Mastercycler nexus							*	*			°
Mastercycler nexus X2								*	*			°	
Takara	TP3000							*	*		°		
Real-Time PCR	ABI	ViiATM 7					*					°	
		ViiATM 7 Fast				*						°	
		7000					*					°	
		7300/7500					*					°	
		7500 Fast				*						°	
		7900HT				*						°	
		7900HT Fast				*						°	
		Stepone Plus				*	*					°	
		QS7, QS3, QS5, QS6, QS6 Flex, QS6 Pro, QS7, 057 Flex, 057 Pro, QS 12K					*						°
		QS3, QS5, QS6, QS6 Flex, 057, 057 Flex, QS 12K in Fast Module					*						°
	Bio-Rad	CFX96	°	°	°	°					*	*	°
		CFX96 Touch	°	°	°	°					*	*	°
		CFX Connect	°	°	°	°					*	*	°
		CFX96 Touch Deep Well	°	°	°	°					*	*	°
		CFX opus 96	°	°	°	°					*	*	°
		iCycler iQ							*	*			°
		iQ5							*	*			°
		MyiQ, MyiQ2							*	*			°
		Opticon, Opticon2	°	°	°	°					*	*	°
		Chromo4	°	°	°	°					*	*	°
Roche	LightCycler 96	*	°	*	°							°	
	LightCycler 480	*	°	*	°							°	
Jena	qTOWER3G							*	*			°	
	qTOWER3G touch							*	*			°	
Agilent	AriaMx	*	°	*	°							°	
	Mx3000/3005P							*	*			°	

* Highly recommended ° Compatibility

Sealing Films

Fisher Plate Sealing Films include Pressure-sensitive Sealing Film and Adhesive Sealing Film. The use of high-performance polyester film materials ensures no deformation during the cycle of heating and cooling. The new adhesive layer makes the sealing film easier to separate from the plate without sticking or hanging any liquid, ultimately reducing contamination.

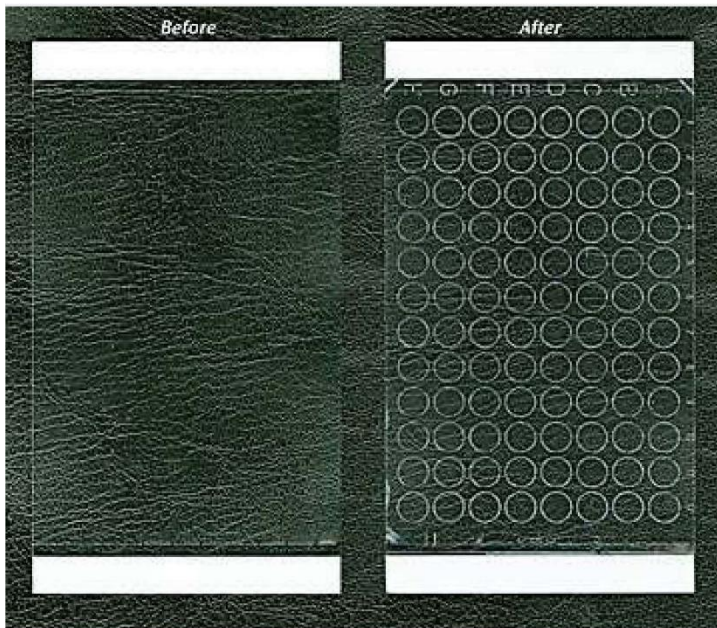

Comparison of Fisher pressure-sensitive plate Sealing Film before and after the experiment.

At the end of the experiment, it is easy to tear off the sealing film without sticking and hanging any liquids, or any thermal deformation.

Cat.No.	Features	Description	Packing
FS-2021-S	Pressure-sensitive	Sensitive qPCR Plate Sealing	100 Sheets/Box
FS-2202A	Adhesive	Clear Adhesive qPCR Plate Sealing Film	100 Sheets/Box
FS-2023-AL	Aluminium	Aluminium Sealing Film	100 Sheets/Box
FS-P2301	Silicone	PCR Silicone Sealing Mat	50 pcs/Box



Centrifuge Tube

Fisher Centrifuge Tubes are made of medical-grade pure polypropylene. The fully automatic production process provides stable, uniform and reliable quality, which allows the tubes withstand greater centrifugal pressure. Our ultra-clean production line ensures no heavy metals and metal ions and DNase, RNase, Pyrogen free. Each Microcentrifuge Tube has a safety lock to prevent from leaking and contaminating.



Microcentrifuge Tube

► Product Features

- Made of medical-grade pure polypropylene, has smooth tube wall with less droplets hanging;
- Various sizes available, 0.2, 0.5, 1.5, 2.0 ml, etc;
- All tubes can be autoclavable;
- A safety lock to make it secure;
- Special designed tube bottom, ensure the solution can be poured without residue;
- Innovative tube body design and integrated injection molding, has high mechanical stability.





FS-0452-2



FS-20003-1.5



FS-30003-2.0

Cat.No.	Volume	Description	Packing
FS-0452-2	0.2 ml	Individual PCR Tube with Optical Flat Cap, 0.2 ml	1000 Tubes/Bag
FS-20003-1.5	1.5 ml	Conical-Bottom Centrifuge Tube, 1.5 ml	500 Tubes/Bag
FS-30003-2.0	2.0 ml	Round-Bottom Centrifuge Tube, 2.0 ml	500 Tubes/Bag

Conical-Bottom Centrifuge Tube

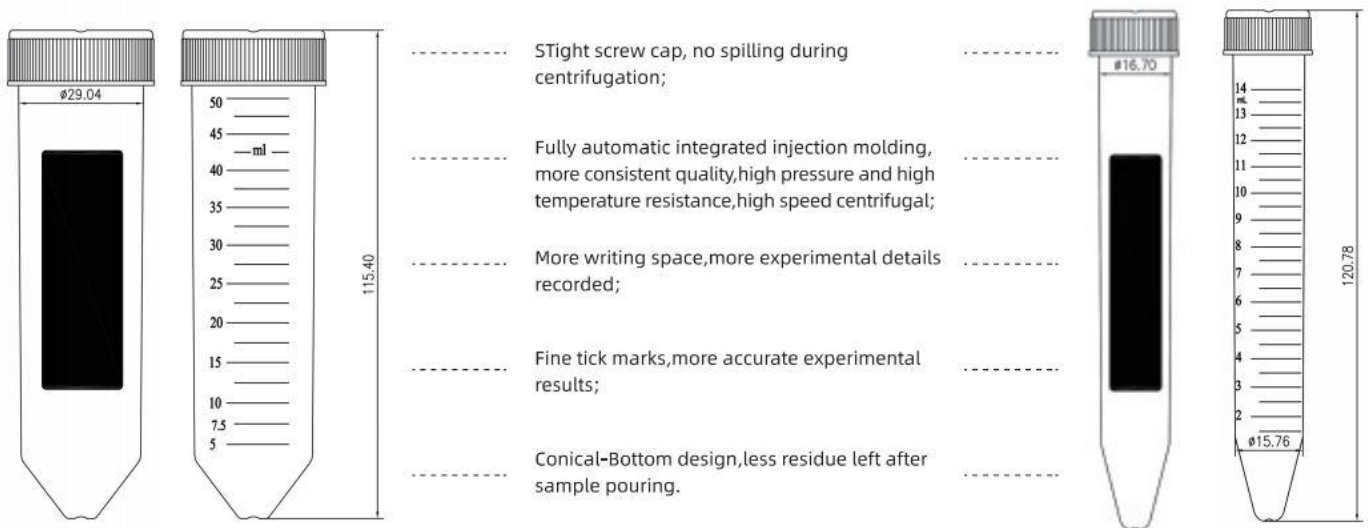

Cat.No.	Volume	Description	Packing
FS-4003-15	15 ml	Sterile Graduated Conical-Bottom Centrifuge Tube, 15 ml	500 Tubes/Bag
FS-5003-50	50 ml	Sterile Graduated Conical-Bottom Centrifuge Tube, 50 ml	500 Tubes/Bag

Centrifuge Tube Racks

The centrifuge tube racks are used for temporary storage of centrifuge tubes made of high-density polypropylene material and advanced manufacturing techniques, which makes it durable, tough and high temperature resistance. Different colors and specifications give more options for users.

Cat.No.	Well	Description	Packing
FS-2009	96 well	Reversibile Racks,96wells, For 0.2ml Tubes or Plates	5 Pcs/Bag
FS-3009	24 well	Reversibile Racks,24wells, For 1.5ml&2.0ml Microtubes	5 Pcs/Bag
FS-4009	32 well	Reversibile Racks,32wells, For 1.5ml&2.0ml Microtubes	5 Pcs/Bag
FS-5009	60 well	Reversibile Racks,60wells, For 1.5ml&2.0ml Microtubes	5 Pcs/Bag
FS-6009	80 well	Reversibile Racks,80wells, For 1.5ml&2.0ml Microtubes	5 Pcs/Bag
FS-7009	96 well	Reversibile Racks,96wells, For 1.5ml&2.0ml Microtubes	5 Pcs/Bag
FS-8009	4-way	4-Way Centrifuge Tube Racks, For 1.5ml & 15ml & 50ml Tubes	5 Pcs/Bag
FS-9009	3-layer	3-Way Centrifuge Tube Racks, For 1.5ml & 15ml & 50ml Tubes	1 Pcs/Bag

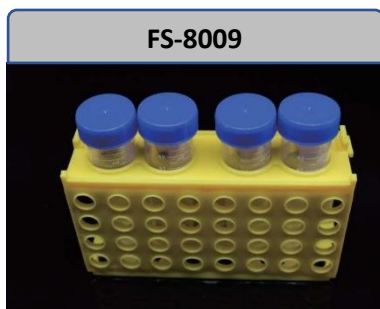
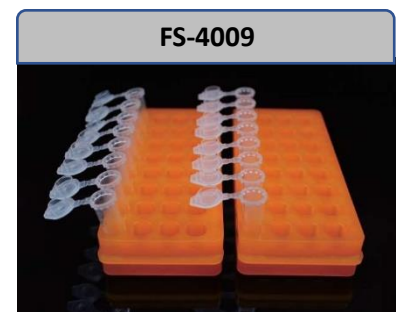

Cryovial Tubes

Cryovial, manufactured from ultra clear polypropylene. The tube is transparent, external thread, screw cap, white O-ring, printed graduation lines, bag pack.

Leak-proof at -95kPa (14psi); Maximum accuracy of graduations at $\pm 2\%$; DNase/RNase-free; Non-pyrogenic <0.25EU/mL

Cat.No.	Volume	Description	Packing
FS-93300-1	1.2 ml	Cryovial, External thread with Silicone washer seal, Self-standing; Non-pyrogenic	100/Bag
FS-93300-2	2 ml	Cryovial, External thread with Silicone washer seal, Self-standing; Non-pyrogenic	100/Bag
FS-93300-3	3 ml	Cryovial, External thread with Silicone washer seal, Self-standing; Non-pyrogenic	100/Bag
FS-93300-4	4 ml	Cryovial, External thread with Silicone washer seal, Self-standing; Non-pyrogenic	100/Bag
FS-93300-5	5 ml	Cryovial, External thread with Silicone washer seal, Self-standing; Non-pyrogenic	100/Bag

FS-93300-1



FS-93300-2



Storage Boxes

Thanks to the different construction materials and sizes, Fisher boxes allow researchers to keep different varieties of test tubes in optimal condition

Storage Plastic Boxes

► Product Features

The Fisher Storage Boxes are made of Polypropylene, with hinged lid, suitable for 1.5 and 2.0 ml tubes. The boxes are available in 2 sizes:

- 9 x 9 for **81 tubes** 130 x 130 x 45 mm
- 10 x 10 for **100 tubes** 150 x 140 x 55 mm

All the boxes are autoclavable at 121 °C

Cat.No.	Description	Packing
STB-081	81 wells Storage Box for 1.5 mL & 2.0 mL Tube	5 Pcs/Box
STB-100	100 wells Storage Box for 1.5 mL & 2.0 mL Tube	5 Pcs/Box

STB-081



STB-100



Storage Carton Boxes

► Product Features

Ultra-low temperature-resistant cardboard.

- For sample storage even at ultra-low temperatures
- Temperature-resistant down to – 80 °C
- Equipped with a water-repellent standard coating
- highest flexibility: Cryo Boxes can be combined with different grid inserts for tubes from dia. 6 mm to dia. 28 mm
- the Cryo Boxes can be used for larger vessels when the grid is removed



Cryo Boxes, Cardboard, Format 133 x 133 mm

Cat.No.	Height	Description	Packing
FS-BOX1	32 mm	Cryo Box 133x133 mm	10 Pcs/Box
FS-BOX2	50 mm	Cryo Box 133x133 mm	10 Pcs/Box
FS-BOX3	75 mm	Cryo Box 133x133 mm	10 Pcs/Box
FS-BOX4	100 mm	Cryo Box 133x133 mm	10 Pcs/Box
FS-BOX5	130 mm	Cryo Box 133x133 mm	10 Pcs/Box



Grid Inserts for Cryo Boxes, Format 133 x 133 mm

Grid	Tube Dia. mm	Grids Height 25 mm Cod.	Grids Height 30 mm Cod	Grids Height 40 mm Cod	Grids Height 65 mm Cod	Packing
4x4	28.0	FS-214	FS-215	FS-216	FS-217	10 Pcs/Box
5x5	23.0	FS-124	FS-125	FS-126	FS-127	10 Pcs/Box
6x6	19.0	FS-134	FS-135	FS-136	FS-137	10 Pcs/Box
7x7	16.0	FS-144	FS-145	FS-146	FS-147	10 Pcs/Box
8x8	14.0	FS-154	FS-155	FS-156	FS-157	10 Pcs/Box
9x9	11.5	FS-165	FS-166	FS-167	FS-168	10 Pcs/Box
10x10	10.5	FS-175	FS-174	FS-176	FS-177	10 Pcs/Box
12x12	8.5	FS-185	FS-184	FS-186	FS-187	10 Pcs/Box
13x13	8.0	FS-194	FS-195	FS-196	FS-197	10 Pcs/Box
14x14	7.0	FS-204	FS-205	FS-206	FS-207	10 Pcs/Box
16x16	6.0	FS-225	FS-226	FS-227	FS-228	10 Pcs/Box

Cell Culture Plate

Cell culture plates are disposable or reusable shallow containers specifically designed to support the growth and propagation of cells in culture. Plate with TC-treated surfaces allow the adhesion of anchor-dependent cells.



► Product Features

- Made of highly transparent polystyrene material, the light transmittance of the cell culture plate reaches 90%;
- After TC treatment, it is suitable for the culture of adherent cells and semi-adherent cells;
- The bottom design is uniform and flat, and the observed image is clear and not deformed;
- The plate cover is equipped with a condensation ring, which can effectively prevent the contamination of the culture medium or evaporation loss and reduce the edge

Cat.No.	Well	Description	Packing
FS-6W	6	TC treatment, Flat bottom, Highly transparent polystyrenene	50/Box
FS-12W	12	TC treatment, Flat bottom, Highly transparent polystyrenene	50/Box
FS-24W	24	TC treatment, Flat bottom, Highly transparent polystyrenene	50/Box
FS-48W	48	TC treatment, Flat bottom, Highly transparent polystyrenene	50/Box
FS-96W	96	TC treatment, Flat bottom, Highly transparent polystyrenene	50/Box

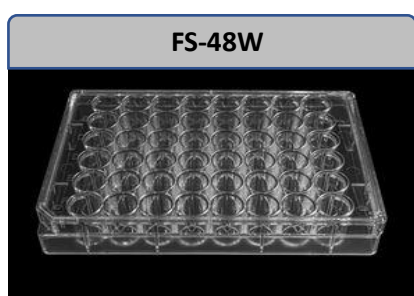
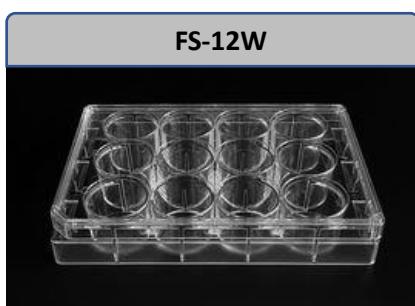
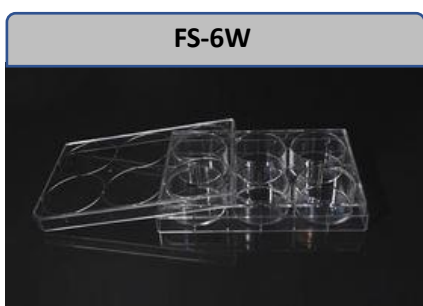

Cell Culture Flask

The FMB Cell culture flasks are specifically designed for successful growth and propagation of cells.



► Product Features

- Made of highly transparent polystyrene material, the light transmittance of the cell flask reaches 90%;
- After TC treatment, it is suitable for the culture of adherent cells and semi-adherent cells;
- Electron beam sterilized, no DNA enzyme, no RNA enzyme, no pyrogen (no endotoxin).
- All the flasks have a vented filter cap
- The bottle mouth has a curved angle for easy pipetting. The bottleneck has a frosted design for labeling. There is a volume scale on the bottle side for observing the liquid volume.

Cat.No.	Volume	Description	Packing
FS-25F	50 ml	25 cm ² Cell Culture Flask, TC-treated, Vented	200 pcs/Bag
FS-75F	150 ml	75 cm ² Cell Culture Flask, TC-treated, Vented	100 pcs/Bag
FS-175F	600 ml	175 cm ² Cell Culture Flask, TC-treated, Vented	30 pcs/Bag

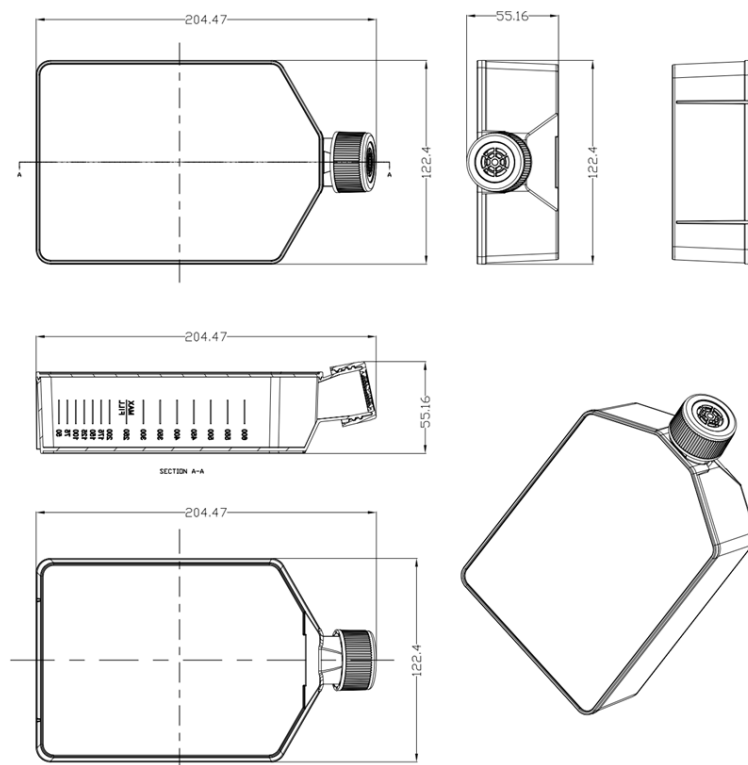

Cell Culture Dish

Cell culture dishes are containers specifically designed to support the growth and propagation of cells in culture. Dishes with pre-treated surfaces allow the adhesion of anchor-dependent cells, while untreated dishes support the culture of suspension cells.

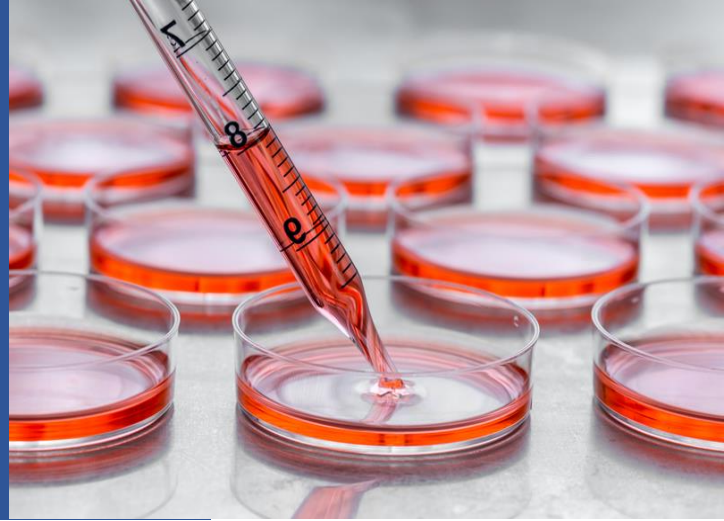

▶ Product Features

- Made of highly transparent polystyrene material, after TC treatment, it is suitable for the culture of adherent cells and semi-adherent cells;
- The bottom design is uniform and flat, and the observed image is clear and not deformed

Cat.No.	Size	Description	Packing
FS-CCD35	35 mm	Cell culture dish,PS,TC treated, DNase&RNase, free,sterile	500 pcs
FS-CCD60	60 mm	Cell culture dish,PS,TC treated, DNase&RNase, free,sterile	500 pcs
FS-CCD100	100 mm	Cell culture dish,PS,TC treated, DNase&RNase, free,sterile	500 pcs
FS-CCD150	150 mm	Cell culture dish,PS,TC treated, DNase&RNase, free,sterile	500 pcs
FS-CCD150H	150 mm	Cell culture dish,PS,TC treated, DNase&RNase, free,sterile, (Individually Wrapped)	500 pcs



Cytology Brush

Fisher Cytology Brush The Celebrity Cytology Brush is indicated for acquiring tissue samples used for the diagnosis of suspected pathology.

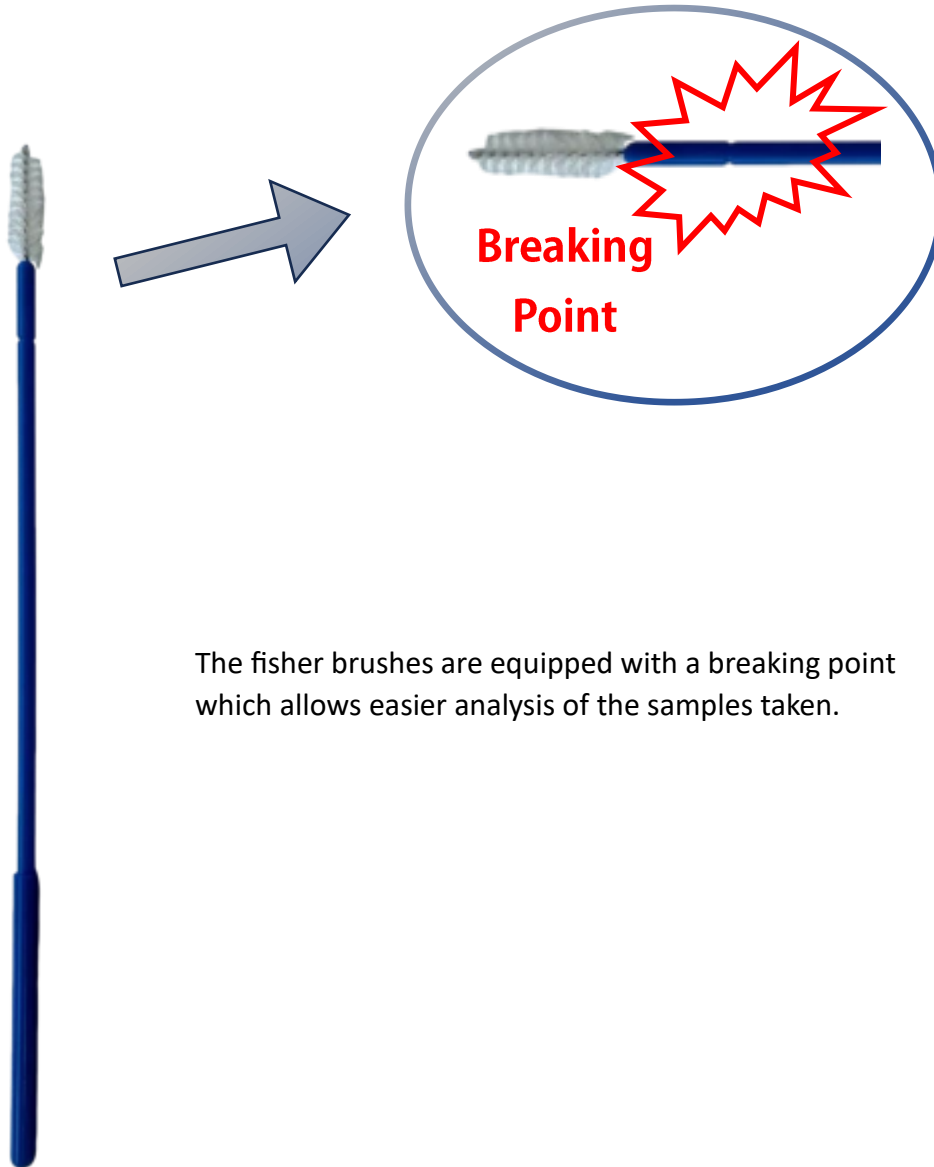

The fisher brushes are equipped with a breaking point which allows easier analysis of the samples taken.

Cat.No.	Description	Packing
FS-100CB	Breaking point for an easier brush separation	3000 Pcs/Box



Gloves

Fisher Nitrile gloves are manufactured on fully automatic production lines with reliable quality. It has a comfortable fit that meets and adapts to your extended wear during your experiments. It also has extremely high sensitivity, excellent tensile and puncture resistance, high tensile strength and excellent abrasion resistance.

Cat.No.	Size	Description	Packing
NS-1009 S	S	Disposable Nitrile Examination Gloves, Small	100 Pcs/Box
NS-1009 M	M	Disposable Nitrile Examination Gloves, Medium	100 Pcs/Box
NS-1009 L	L	Disposable Nitrile Examination Gloves, Large	100 Pcs/Box
LS-1009 S	S	Disposable Latex Examination Gloves, Small	100 Pcs/Box
LS-1009 M	M	Disposable Latex Examination Gloves, Medium	100 Pcs/Box
LS-1009 L	L	Disposable Latex Examination Gloves, Large	100 Pcs/Box

► Choose the right size for your hand

Measurement:

Keep your palms straight. Measure from the junction of your thumb and index finger to the edge of your palm, then select the corresponding size according to the size chart.

(see right picture)

< 7 cm	XS
7-8 cm	S
8-9 cm	M
> 9 cm	L

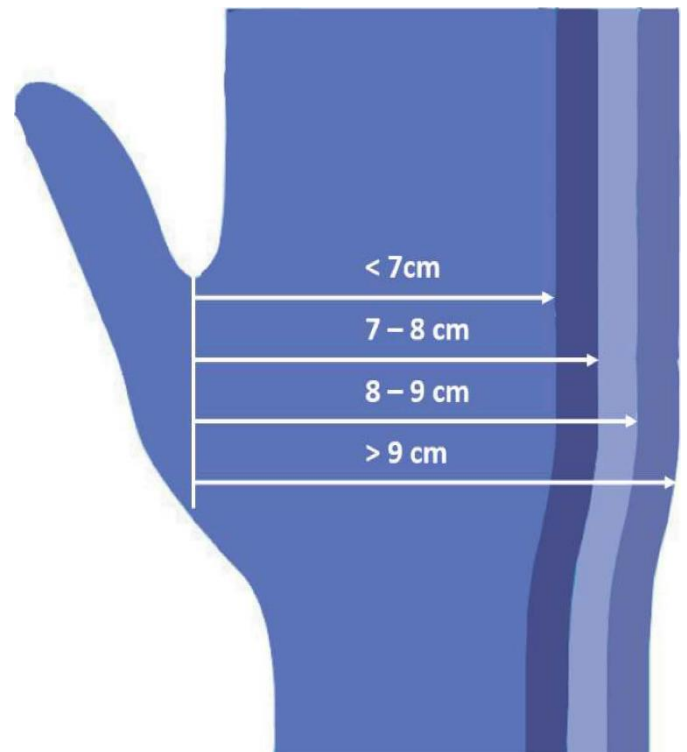

There will be a certain tolerance around 5-10mm due to different hand shapes and measurement methods. This chart is only an approximate size, gloves should be tried on to confirm best fit.



SOCIETÀ ITALIANA CHIMICI
Life Sciences

Via Rio nell'Elba, 140 – Rome / ITALY

Phone +39 06-8818936 / 8800211 – Fax +39 06-8815319

Email info@sichim.com Web-Site www.sichim.com